



techpol.com.tr



Think Future



TECHPOL

OTOMOTIV SANAYİ TİCARET A.Ş.

BLOCKS POLYURETHANE POLYURETHANE BLOCKS



PUR (POLYURETHANE)



**PUR BLOCK POLYURETHANE
FAIBLE DENSITE
(35-37-40-42 DENSITE)**

**PUR POLYURETHANE BLOCK
LOW DENSITY
(35-37-40-42 DENSITE)**

**PUR BLOCK POLYURETHANE
HAUTE DENSITE
(50 DENSITE)**

**PUR POLYURETHANE BLOCK
HIGH DENSITY
(50 DENSITY)**

PIR (POLYISOCYANURATE)



**PIR BLOCK POLYISOCYANURATE
FAIBLE DENSITE
(35-37-40-42 DENSITE)**

**PIR POLYURETHANE BLOCK
LOW DENSITY
(35-37-40-42 DENSITE)**

**PIR BLOCK POLYISOCYANURATE
HAUTE DENSITE
(50 DENSITE)**

**PIR POLYURETHANE BLOCK
HIGH DENSITY
(50 DENSITY)**



MOUSSE POLYURETHANE POLYURETHANE SHEETS



PUR (POLYURETHANE)



**PUR PLAQUE POLYURETHANE
FAIBLE DENSITE**
(35-37-40-42 DENSITE)

**PUR POLYURETHANE SHEET
LOW DENSITY**
(35-37-40-42 DENSITY)

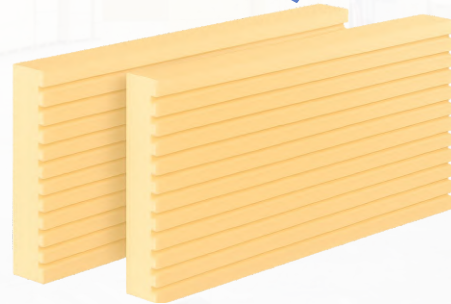

**PUR PLAQUE POLYURETHANE
HAUTE DENSITE**
(50 DENSITE)

**PUR POLYURETHANE SHEET
HIGH DENSITY**
(50 DENSITY)

PIR (POLYISOCYANURATE)



**PIR PLAQUE POLYISOCYANURATE
FAIBLE DENSITE**
(35-37-40-42 DENSITE)

**PIR POLYURETHANE SHEET
LOW DENSITY**
(35-37-40-42 DENSITY)



**PIR PLAQUE POLYISOCYANURATE
HAUTE DENSITE**
(50 DENSITE)

**PIR POLYURETHANE SHEET
HIGH DENSITY**
(50 DENSITY)



ISOLATION DE TUYAUX ET RESERVOIRS EN POLYURETHANE POLYURETHANE PIPE AND TANK INSULATION

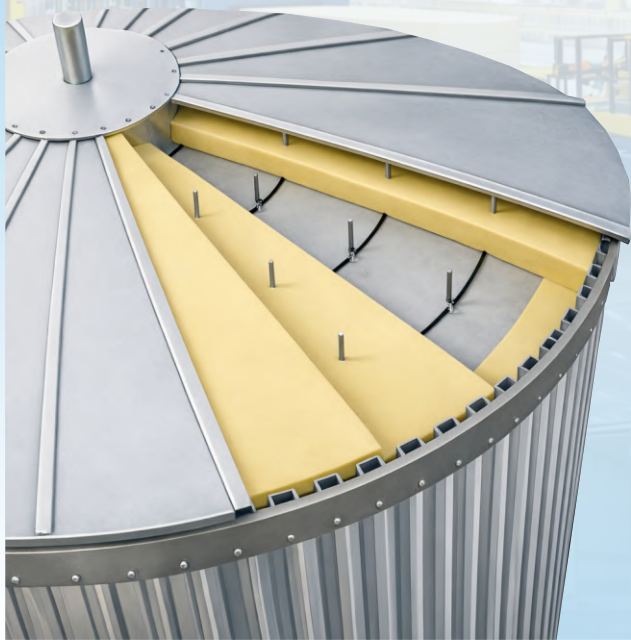
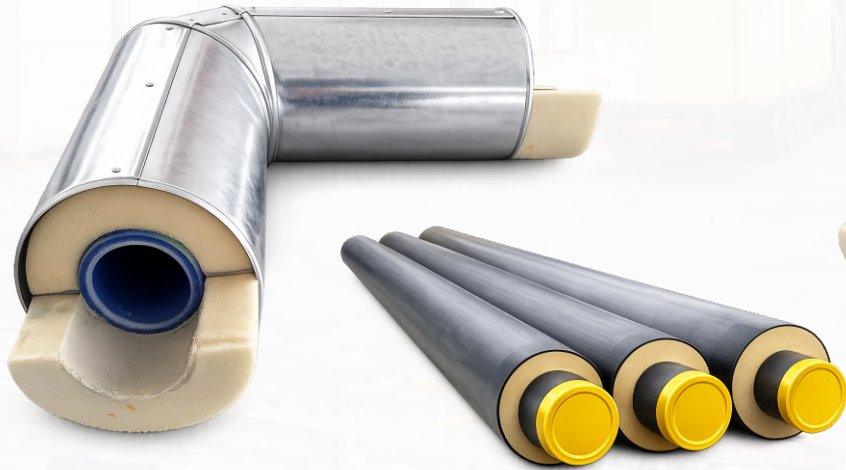

XPS (POLYSTYRENE EXTRUDE) XPS (EXTRUDED POLYSTYRENE)



25-40 Densite
25-40 Density

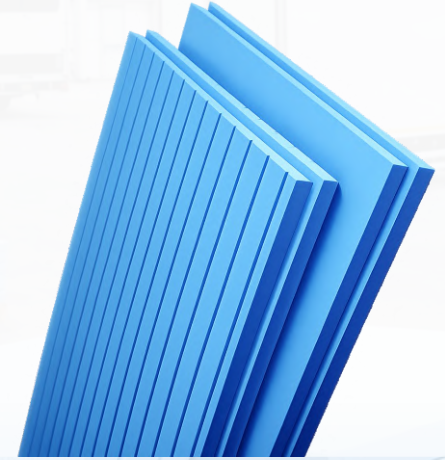
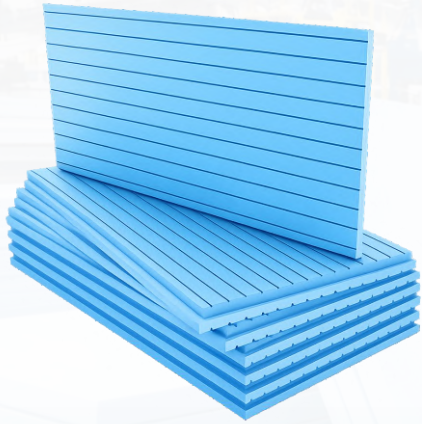

PANNAEAU SANDWICH SANDWICH PANEL

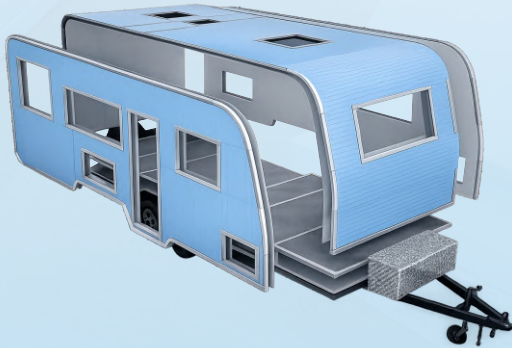
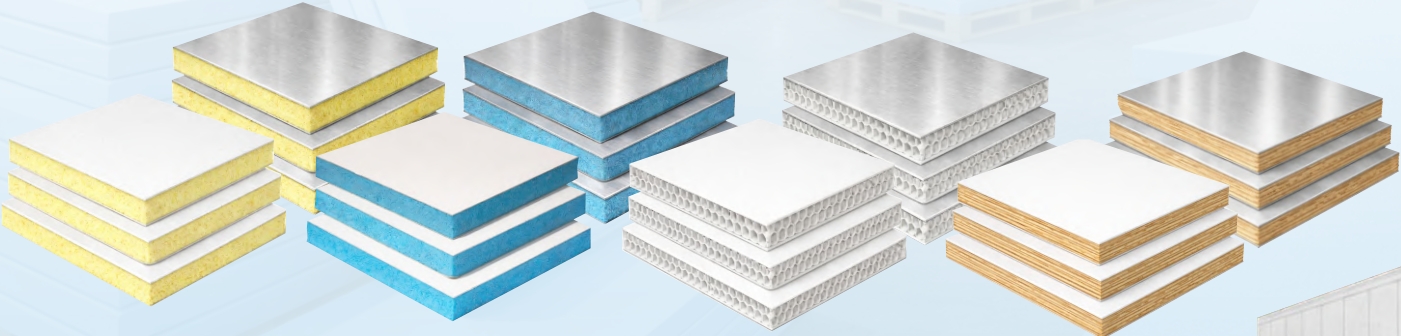
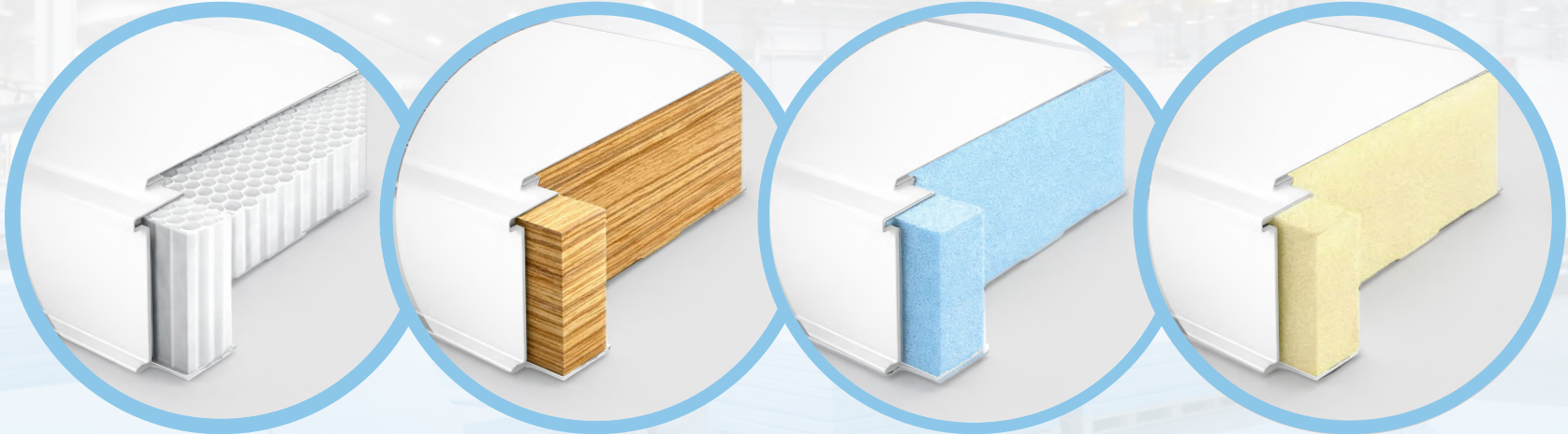

PORTES ET RIDELLES EN ALUMINIUM ALUMINIUM DOOR AND SIDE BOARD



SYSTEME BACHE COULISSANTE RAPIDE QUICK CURTAIN SYSTEM



SYSTEME BACHE LATERALES ET TOIT COULISSANTE SIDE CURTAINS AND SLIDING ROOF SYSTEMS

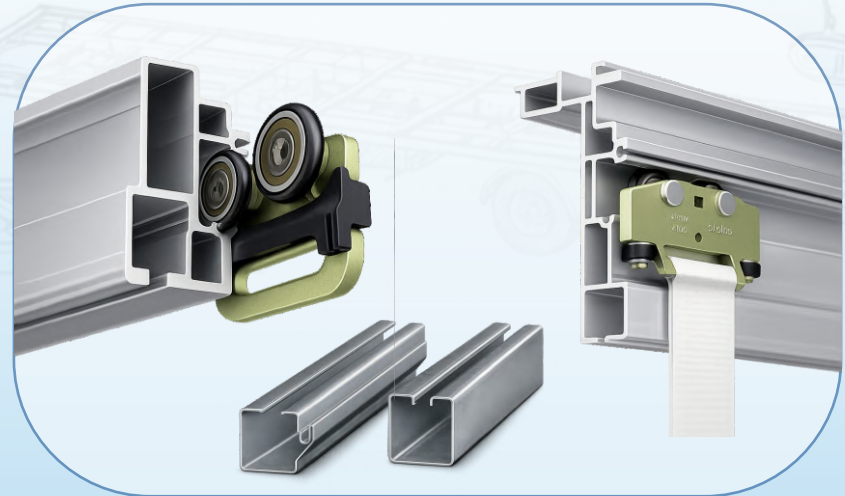

SYSTEMES STRUCTURE DE CAISSES FRIGORIFIQUES REFRIGERATED BODY SUPERSTRUCTURE SYSTEMS

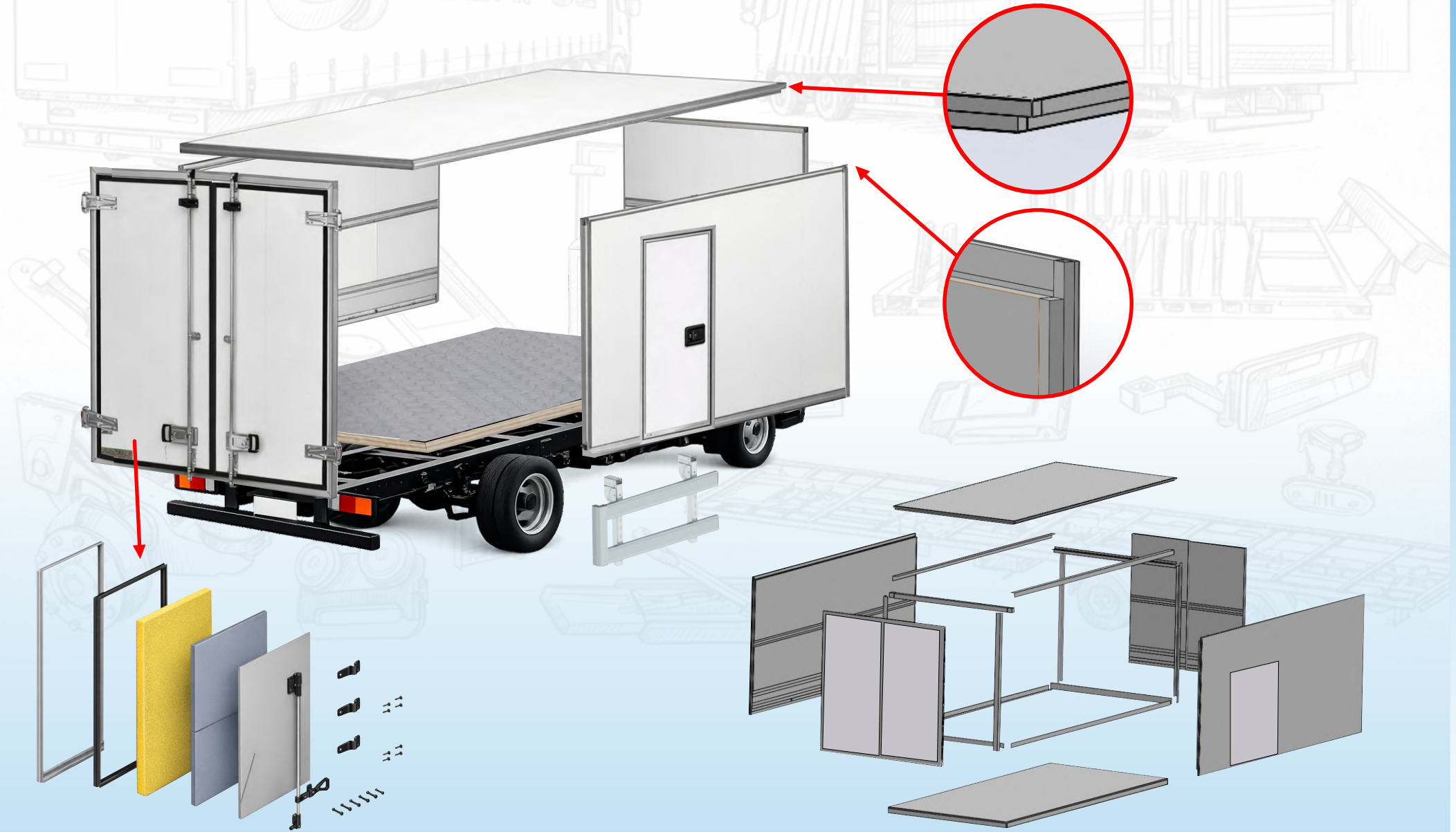

SYSTEMES DE REMORQUE BACHES LATERALES COMPLETES COMPLETE SIDE CURTAIN TRAILER SYSTEMS



SYSTEME SUPERSTRUCTURE POUR PLATEAUX A RIDELLES OPEN-BOXED COVERED SUPERSTRUCTURE SYSTEMS



CONTREPLAQUES PLYWOODS



CONTREPLAQUES SANS FILME
PLYWOOD



CONTREPLQUE A TREILLIS (GRIS)
WIRE MESH PLYWOOD (Grey)



CONTREPLAQUE HEXAGONALE (GRIS)
HEXAGONAL PLYWOOD (Grey)

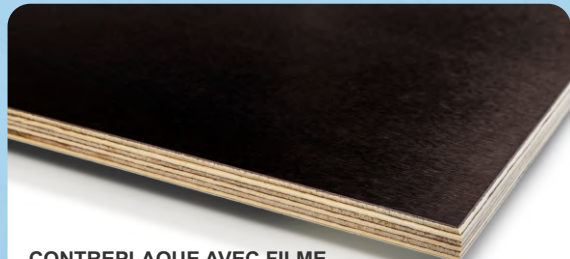

CONTREPLAQUE AVEC FILME
PLYWOOD WITH FILM

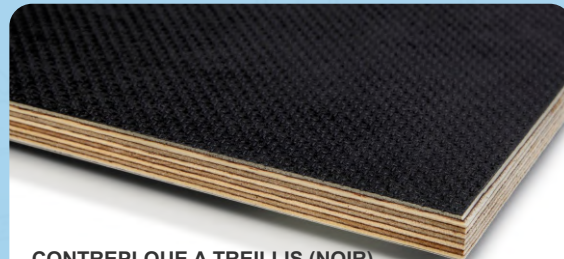

CONTREPLQUE A TREILLIS (NOIR)
WIRE MESH PLYWOOD (Black)



CONTREPLAQUE HEXAGONALE (NOIR)
HEXAGONAL PLYWOOD (Black)



PILIERS LATERAUX PILLARS



PROFILES ALUMINIUM ALUMINIUM PROFILES

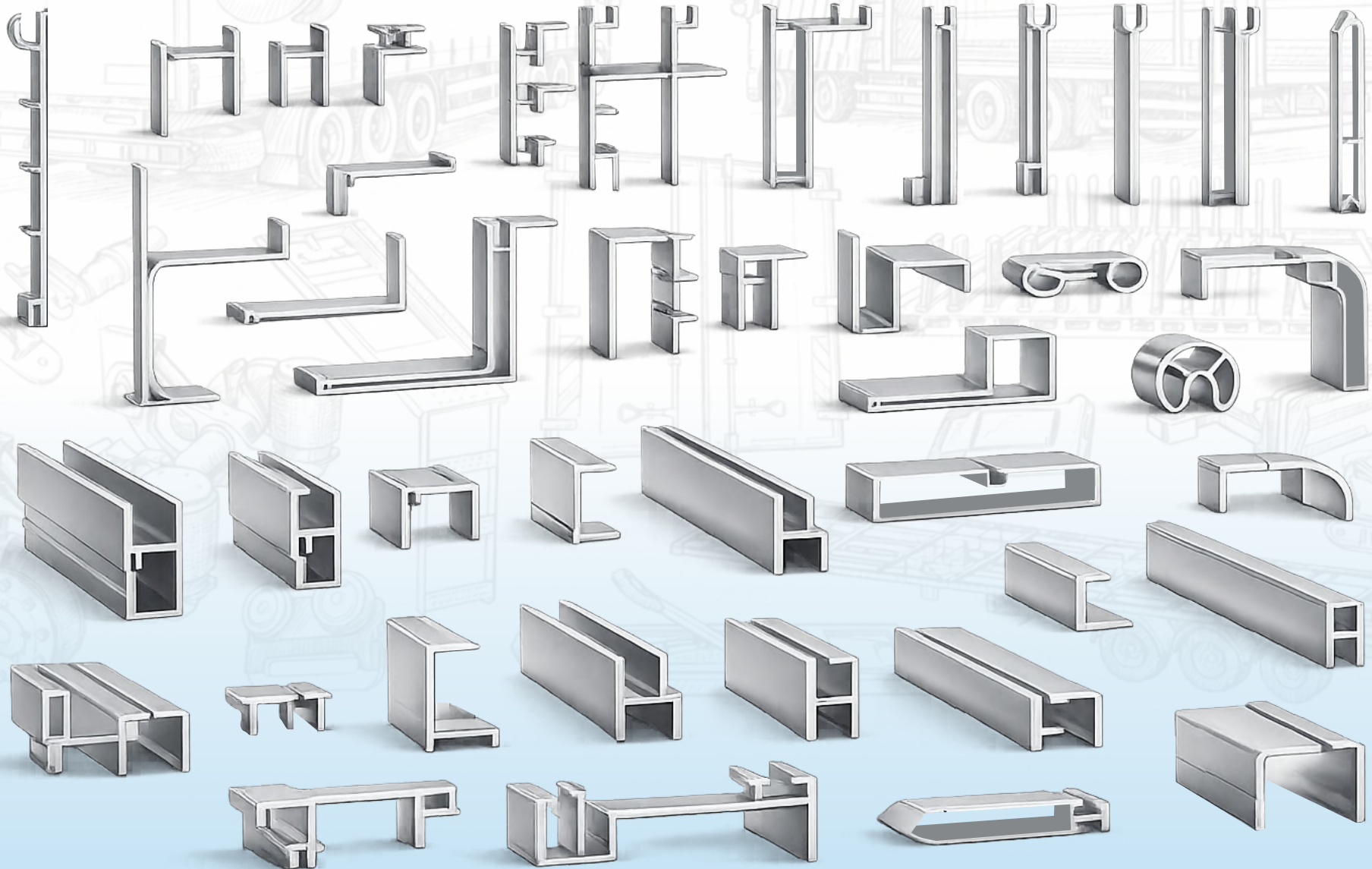

SYSTEMES D'ECLAIRAGE ET REFLECTEURS LIGHTING SYSTEMS AND REFLECTORS

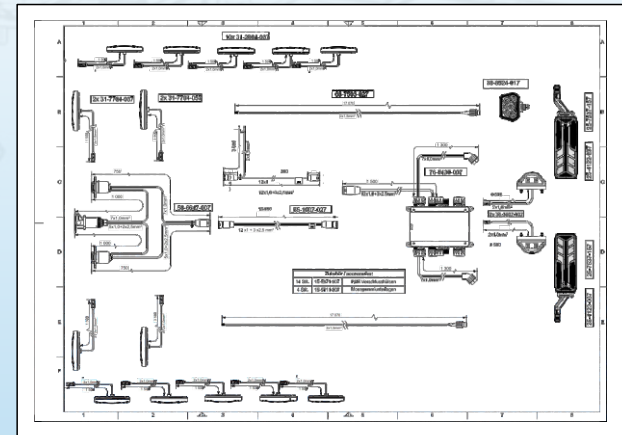
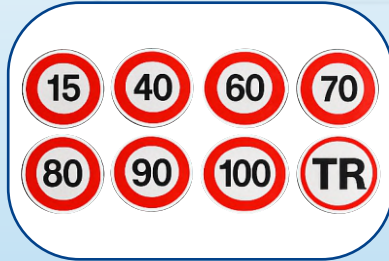
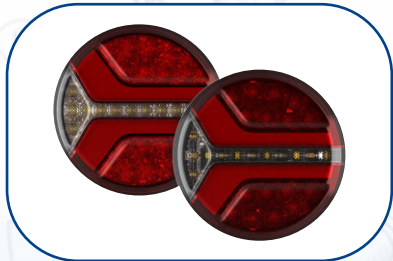

ACCESSOIRES EN PLASTIQUE ET EN METAL PLASTIC AND METAL ACCESSORIES



PRODUITS EN PVC ET EN CAOUTCHOUC

PVC, RUBBER PRODUCTS

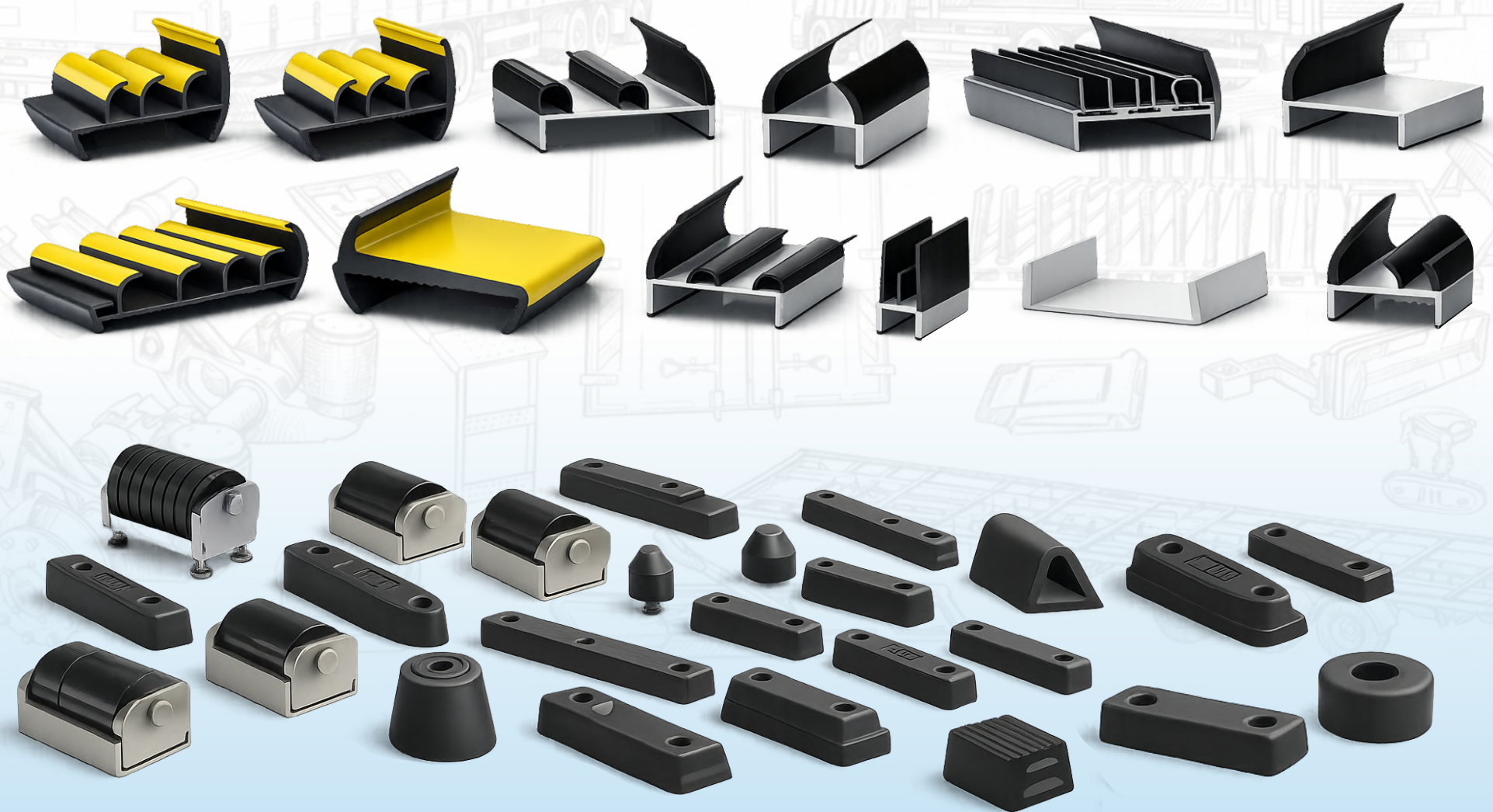

SERRURES ET ENSEMBLES DE FERMETURES

LOCK SETS AND LOCKS

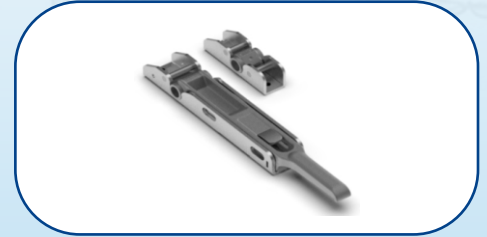
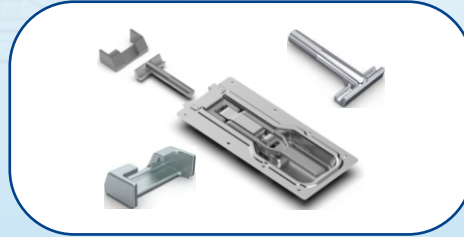
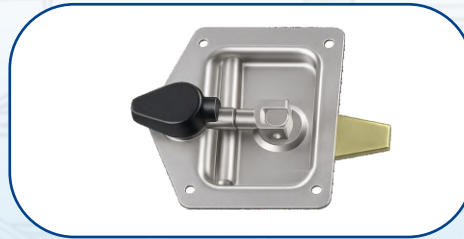

CHARNIERES ET ACCESSOIRES HINGES AND ACCESSORIES





TEC-POL

OTOMOTİV SANAYİ TİCARET A.Ş.

WABCO



Haldex

SAF Holland



JOST



Edscha

SESAM

INDESCAR

TAKLER



DAKEN
LOCKS

DOMAR

ADAICO

RIGA



fibrosan



KLEIBERIT
ADHESIVES • COATINGS

KÖGEL



KRONE

Kässbohrer
Driven by professionals®

WIELTON

Cnt
Flexible Products
Conta

İLETİŞİM CONTACT



Office : +90 262 503 99 21
Departement Export : +90 534 855 64 20
Domestic Sales : +90 539 635 87 37
E-Mail : info@techpol.com.tr
Instagram : [techpol.otomotiv](https://www.instagram.com/techpol.otomotiv)
Linkedin : [techpol-otomotiv](https://www.linkedin.com/company/techpol-otomotiv)

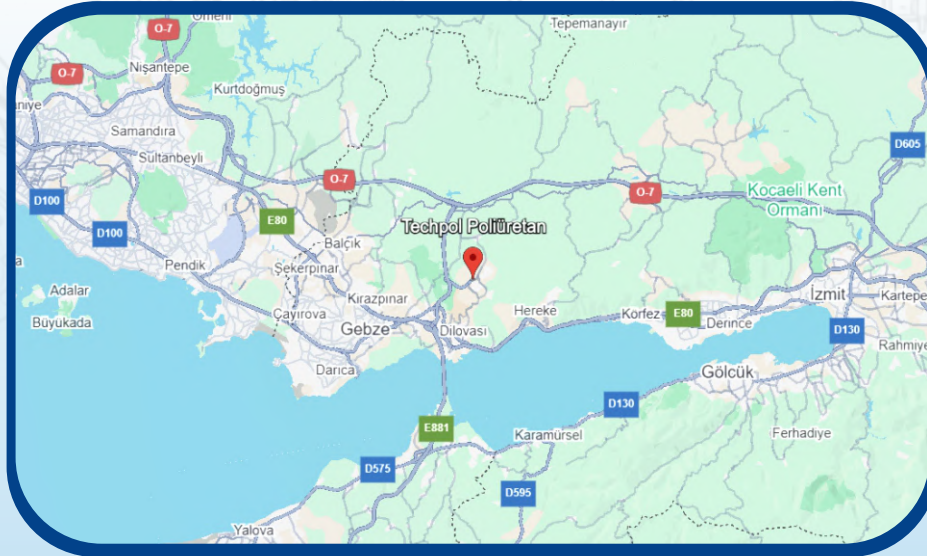

ADRESSE:
Çerkeşli OSB, İmes 5 Bulvarı
No:5, 41455
Dilovası/Kocaeli/Türkiye



google maps
directions